

# AUTOMATIC DIGITAL BLOOD PRESSURE MONITOR

Scian

INSTRUCTION MANUAL  
MODEL : LD-528 – T 528

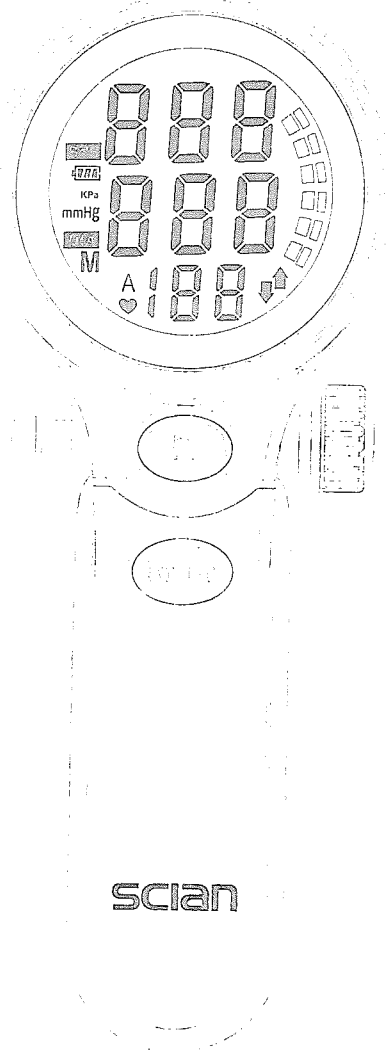



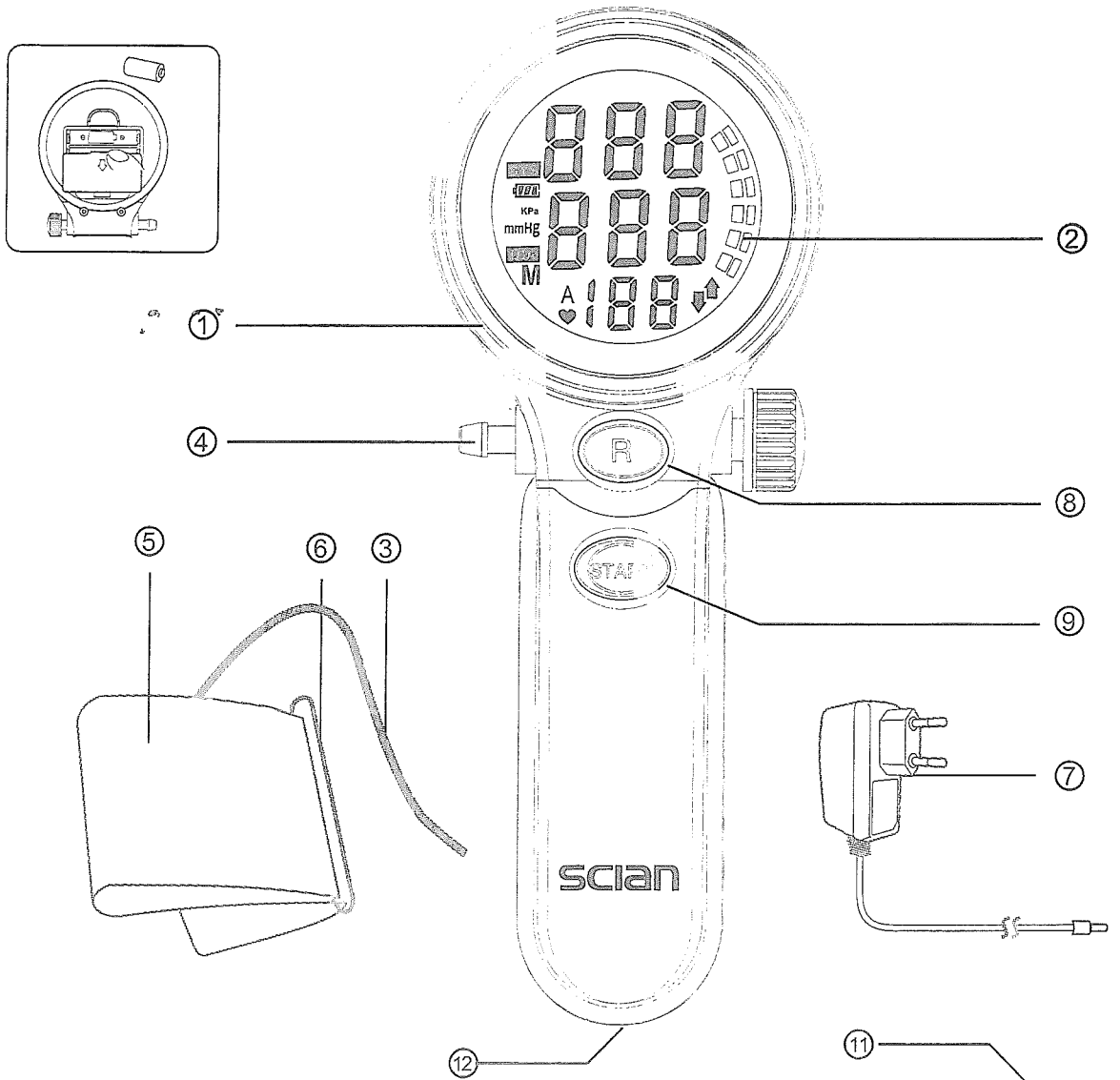



## PARTS AND COMPONENTS

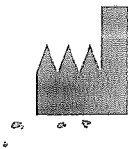

1. Main Body
2. LCD
3. Air Hose
4. Air Connector
5. Cuff
6. D-ring
7. AC Power Adapter
8. Memory Button
9. START button
10. Storage Bag
11. Rechargeable Li-ion battery
12. Adapter outlet

## SYMBOLS

SYMBOLS	MEANING
	<p>Manufacturer</p>
	<p>Authorized Representative in the European community</p>
	<p>Symbol for the marking of electrical and electronics devices according to Directive 2002/96/EC. The device, accessories and the packaging have to be disposed of waste correctly at the end of the usage. Please follow Local Ordinances or Regulations for disposal.</p>
	<p>CE marking in conformity with EC directive 93/42/EEC</p>
	<p>Attention, consult accompanying documents</p>
	<p>Type B Applied Part</p>

## TABLE OF CONTENT

1. GENERAL .....	4
- PRINCIPLE OF OPERATION .....	4
- NEW TECHNOLOGIES USED .....	4
2. TIPS ON TAKING BLOOD PRESSURE MEASUREMENT .....	5
3. BATTERY INSTALLATION .....	7
4. HOW TO USE THE POWER SUPPLY .....	7
Charging .....	7
Battery Change .....	8
5. CORRECT POSTURE FOR MEASUREMENT .....	8
6. ASSEMBLY THE CUFF .....	8
7. CARRY OUT A MEASUREMENT .....	9
- AUTOMATIC INFLATION .....	10
- RAPID DEFLATION DURING MEASUREMENT .....	10
8.WHO BLOOD PRESSURE CLASSIFICATION INDICATION .....	10
9. FUNCTION OF MEMORY .....	11
- MEMORY RECALL .....	11
- MEMORY CLEARANCE .....	11
10. ERR INFORMATION .....	12
11. CARE, STORING, REPAIR AND RECYCLING .....	13
12. TROUBLESHOOTING .....	14
13. WARRANTY OBLIGATIONS .....	14
14. SPECIFICATIONS .....	15
15. BLOOD PRESSURE RECORD .....	16

## GENERAL

This instruction manual is intended to assist the user for safe and efficient operation of the automatic digital blood pressure monitor (hereinafter: device) model LD-528. The device must be used in accordance with the procedures described in the manual. It is important to read and understand the entire manual, especially the section <Tips on taking blood pressure measurement>.

This device is intended for the non-invasive measurement of systolic and diastolic arterial blood pressure and pulse rate in adults (age 15 and above) . Consult the physician if measurement is taken in children or persons with arrhythmia as errors may occur.

### PRINCIPLE OF OPERATION

This device adopts the oscillometric technology with Fuzzy Algorithm measuring the arterial blood pressure and pulse rate. The cuff is wrapped around the arm and automatically inflated by the air pump. The sensor of the device catches weak fluctuation of the pressure in the cuff produced by extension and contraction of the artery of the arm in response to each heartbeat. The amplitude of the pressure waves is measured, converted in millimeters of the mercury column, and is displayed by digital value.



**ATTENTION:** This device can not provide reasonable accuracy if used or stored in the temperature or humidity beyond the range stated in the section < SPECIFICATIONS > of this manual.

### NEW TECHNOLOGIES USED

Fuzzy Algorithm is the processing algorithm taking into account of the speciality of individual heartbeats, which provides higher accuracy of measurement.

## TIPS ON TAKING BLOOD PRESSURE MEASUREMENT

1. It is necessary to know that arterial blood pressure is subjected to sharp fluctuations. The level of the arterial blood pressure depends on many factors. Generally arterial blood pressure is lower in summer and higher in winter. Arterial blood pressure changes with atmosphere pressure and is affected considerably by many factors, e.g. physical loads, emotional excitability, stress, meals, etc. Medicines, drinking, smoking affects greatly the level of individual blood pressure. When blood pressure is measured in hospital, the value is always higher than that at home. The reason is the tensity and such case is especially serious in given group patients, which is known as 'White coat effect' medically. Blood pressure will raise in low temperature, so it is better to take blood pressure measurement in room temperature (approximately 20°C). If this device was stored in low temperature, it is necessary to leave it in room temperature for at least 1 hour, otherwise the measurement can be inaccurate. Blood pressure does vary with age and individual, and it is recommended to write down the readings in blood pressure record daily, then you can check with doctors to find out what is "normal blood pressure".

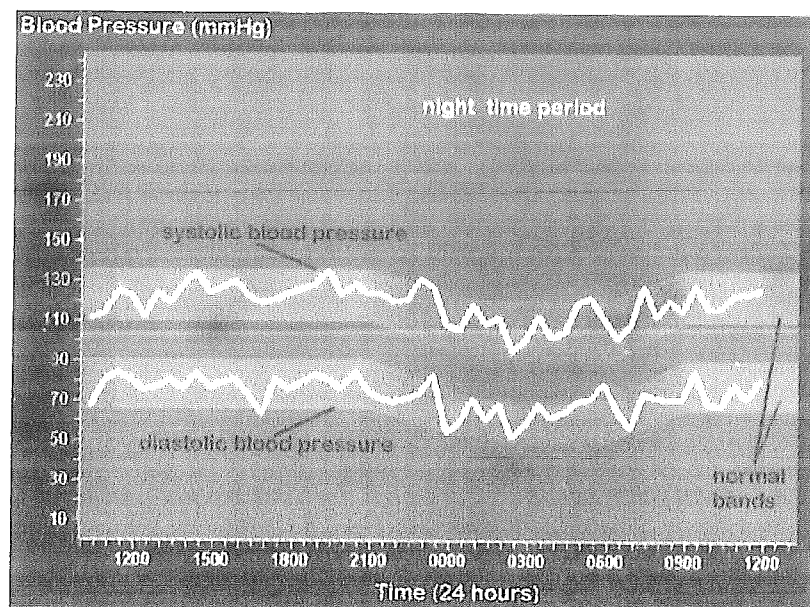

The illustration is from British Hypertension Society

2. Take measurement under doctor's instruction for patients with cardio-vascular diseases.

**Under no circumstances should you alter the dosages of any drugs prescribed by your doctor!**

3. Accurate measurement of blood pressure may be difficult in serious arteriosclerosis, weak pulse, or in patients with obvious fluctuation of heart contraction rhythm. Please consult qualified physician interpret your blood pressure readings.

4. It is necessary to keep quiet during measurement to get accurate readings. Measurement should be conducted in quiet environment at room temperature. Don't eat or smoke before a measurement. This device is supplied with the standard cuff and adult large cuff which are fit for the arm size 22-32 cm. Care should be taken to ensure that the cuff size is appropriate for the person whose blood pressure is being taken. Children and adults with cuff size fall outside the range of the standard cuff size and large adult cuff size should select special size cuffs. Please contact the dealer to get these special size cuffs.



**ATTENTION: Do not use cuffs other than the original cuff contained in this kit!**

5. Repeated measurements with interval at 3 minutes are recommended, so you can calculate the average to get more accurate measurement. Atherosclerosis patients are required longer interval (10-15 minutes) as elasticity of patients' vessels decreased significantly in these diseases. 10-15 minutes interval is also applicable for patients suffering from diabetes for a long time.

#### Classification

- Equipment not suitable for use in the presence of flammable mixtures.
- Internally powered equipment.
- Type B applied part.

## BATTERY INSTALLATION

1. Open the battery cover and install lithium battery into the battery compartment as indicated. Make sure that the polarity is correct;

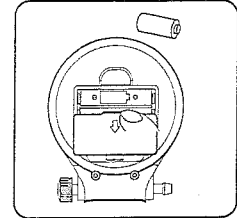

2. Close the battery compartment cover.

- Batteries in this kit are intended to check work capacity of the device and the life-span of the batteries can be shorter than the recommended;
- If the device is to be unused for long time, please take out the batteries;
- Don't leave the worn batteries in the device.

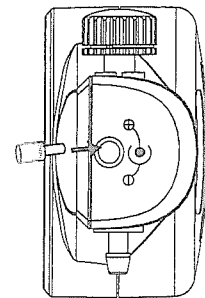

## HOW TO USE THE POWER SUPPLY

This device uses rechargeable battery or adapter as the power supply:

AC Adapter

Output voltage: 5V±5%

Max. output current: At least 1000 mA

Output plug polarity: <+> inner

Rechargeable Battery (Lithium Battery)

Voltage: 3.7V



Capacity: 650mAh





Size: 123A

**Don't use battery or adapter not specified for this device!**

The battery is not charged when you purchase the device. Connect the device to the AC adapter to charge the new battery for more than 4 hours before use. Even if no battery is installed, this device can still work with the adapter.

### Charging

Please charge the battery with the adapter when there is low battery indication '  ' flashing or '  ' in the LCD or nothing after START button is pressed.

When the adapter is connected, the adapter will charge the installed rechargeable battery automatically. At the same time the LCD will show '  ->  ->  ->  ' circularly. Once the battery is fully charged, '  ' will show in the LCD.



## Battery Change

The device can provide at least 200 times measurement with battery fully charged. Approximate life for the rechargeable battery is 2 years, and when the icon '  ' appears frequently even you charge it timely, please change the rechargeable battery with new one.

1. Open the battery cover and install the rechargeable battery specified into the battery compartment as indicated. Make sure that the polarity is correct;
2. Close the battery compartment cover.

### Caution:

Disposal of discarded battery should be in conformance with local regulations.

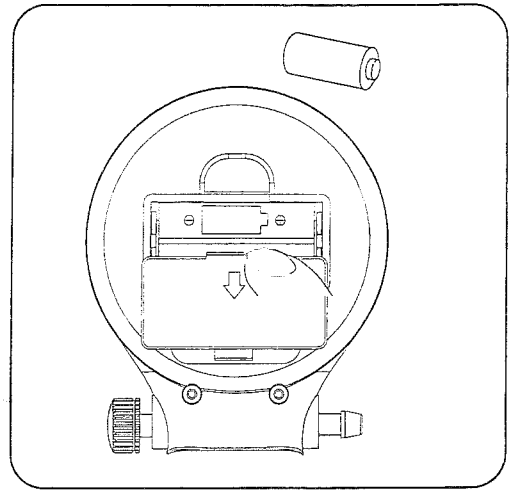

## CORRECT POSTURE FOR MEASUREMENT

1. Sit at the table and let the table support your arm as you take the measurement. Make sure that the cuff on the upper arm is at approximately the same level as the heart, and that the forearm is extended naturally on the table;

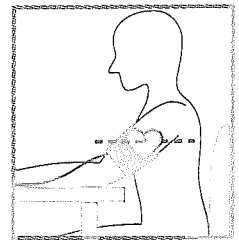

2. You may lie on your back and take measurement. Look at the ceiling, keep calm, and don't move your neck or body during the measurement. Make sure that the cuff on the upper arm is at approximately the same level as the heart.

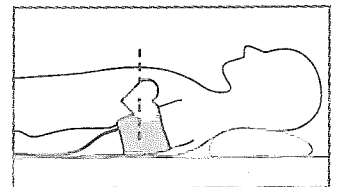

## ASSEMBLY THE CUFF

1. Insert the edge of the cuff approximately 5 centimeters into the D-ring as shown in figure.

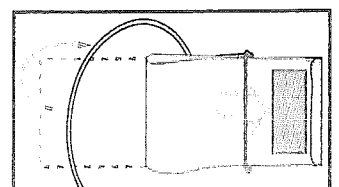

2. Put the cuff on the left upper arm with the tube pointing to the direction of palm. If measurement on your left arm is difficult, you can use right arm for measurement. In this case, it is necessary to know that the readings may differ about 5-10 mmHg between left arm and right arm.

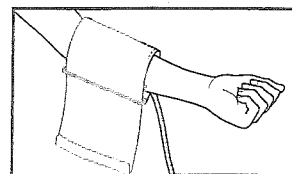

3. Wrap cuff around your upper arm with the lower edge of the cuff approximately 2-3 centimeters above the elbow. The mark <ARTERY> must be over the artery of the arm.

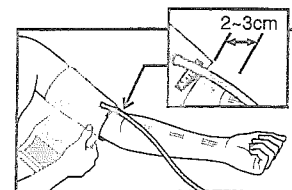

4. Press the cuff to make sure that it is attached securely. The cuff should not be too tight or too loose. Two fingers should be easily put in between cuff and upper arm.

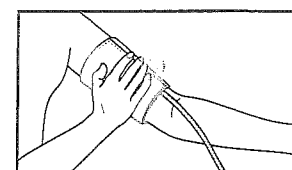

5. The mark <INDEX> on the cuff must point to area <NORMAL> or <LARGE CUFF>. This means the cuff size is correct. If mark <INDEX> points to the area beyond area <NORMAL>, or <LARGE CUFF> please consult your dealer whether you need another size cuff.

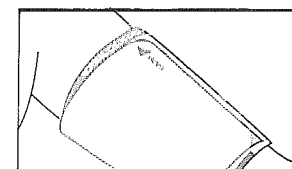

6. Sometimes it is difficult to make the cuff regular owing to the shape of the user's upper arm, the cone-shape assembly of cuff is also acceptable.

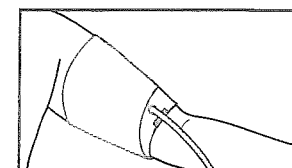

7. If your clothes restrict blood circulation of your upper arm, or you roll your sleeve up so as to result in such restriction. Please take off your clothes to get accurate measurement if necessary.

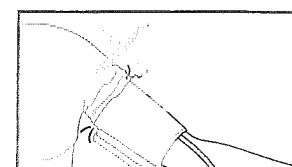

## CARRY OUT A MEASUREMENT

1. Insert the air hose into the air connector. Before the measurement, take 3~5 times deep breath and relax yourself. Don't talk or move your arm;

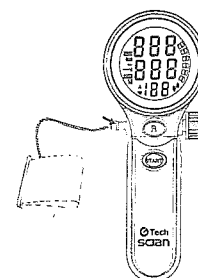

2. Press button 'START', and all symbols will appear on display in 2 seconds. Then two short beep will sound and '0 mmHg' will appear on the screen. Pump begins to inflate with display showing the reading of pressure. Generally the pressure will reach 190mmHg;

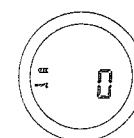

3.The pump stop inflating and pressure begins to decrease gradually, during which the user's blood pressure and pulse will be calculated;

4. There will be a long beep following the accomplishment of measurement. The air in the cuff will deflate quickly and the blood pressure reading, pulse reading will show in the display;

5. Press the button 'START' to turn off the device. Please rest for at least 3 minutes for another measurement. If the power supply is not switched off and the device keeps unused for 3 minutes, the device will be switched off automatically.

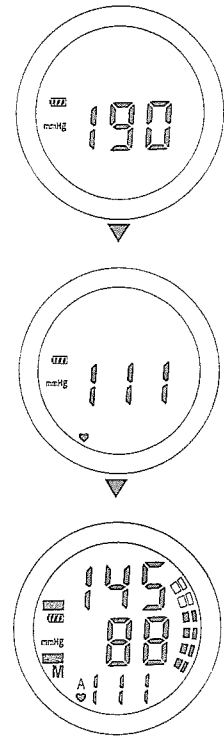

#### AUTOMATIC INFLATION

There are 4 given levels of given inflation pressure for this device 190mmHg, 230mmHg, 270mmHg and 300mmHg. When 190mmHg is not enough or movement of arm occurs, the device will automatically inflate to reasonable pressure level to ensure a successful measurement, it is not a fault.

#### RAPID DEFLATION DURING MEASUREMENT

If you do not feel well during measurement or want to stop the measurement for some reason, you can press the START button, The device will quickly release the air in cuff and the device will be switched off.

### WHO BLOOD PRESSURE CLASSIFICATION INDICATION

Standards for assessment of high or low blood pressure, regardless of age, have been established by World Health Organization(WHO) as show in the chart as below:

The indicator displays a segment, based on the current data, corresponding to the WHO classification.

For example, if your blood pressure is 145mmHg (Systolic Pressure), 88mmHg (Diastolic Pressure), according to the world health organization standard, your

blood pressure level is Mild Hypertension.

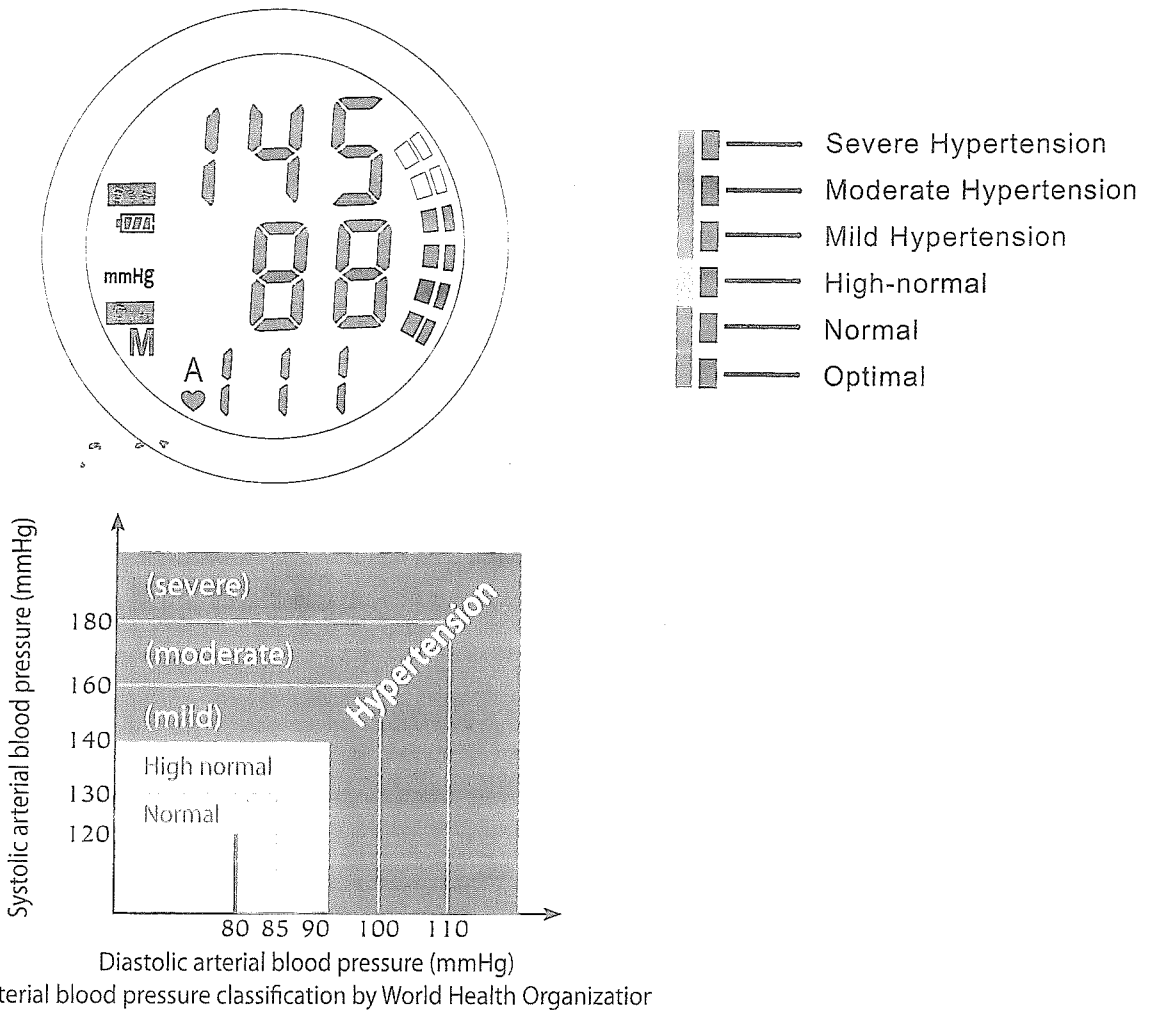

**Note:** If the systolic blood pressure and diastolic blood pressure fall into different categories, the higher value should be taken for classification

## FUNCTION OF MEMORY

### MEMORY RECALL

1.LD-528 can store 90 sets of readings and automatically calculate the average value of the latest 3 readings. When the memory is full (90 sets of readings are stored), the oldest reading will be replaced by new one automatically. Memory will not clear away even if power supply is removed;

2. After a measurement or when the device stands by, the user can press R button to recall memory. Press R button, the display will show the average value of the latest 3 readings;

3. Press again, the display will show '01', which means the latest reading, then turns to another screen to show readings;

4. Press again, the display will show '02', which means the second to the latest reading...

### MEMORY CLEARANCE

After a measurement is finished or when the device stands by, hold down R button for at least 5 seconds, the display will show 'CLR' which means all the stored reading are removed.

## ERROR INFORMATION

INDICATION	POSSIBLE REASON	CORRECTION METHODS
	<p>The cuff is put on wrongly or the tube plug is inserted too loosely.</p> <p>Movement of arm/hand or talking during measurement.</p> <p>The cuff is not inflated to necessary pressure.</p>	<p>Make sure that cuff is put on correctly and the tube plug is inserted tightly and repeat the measurement</p> <p>Repeat the measurement with following completely recommendations of manual</p> <p>Repeat the measurement with pumping cuff to higher pressure.</p>

## CARE, STORING, REPAIR AND RECYCLING

1. It's necessary to protect this device against high moisture, direct sunlight, shock, solvent, alcohol and gasoline.
2. Remove the batteries if the device is to be stored for a long time and keep the batteries far from the children.
3. Keep the cuff from sharp subject and don't extend or twist the cuff.
4. Use only soft and dry cloth to clean the device.
5. The cuff are sensitive and must be handled with care. You can clean the cuff cover with damp cloth as daily maintenance.

To avoid across infection when share the cuff, you can sanitary treatment of inner side of fabrics cover of the cuff and contacting with help of cotton wool tampons, moistened by 3% solution of hydrogen dioxide. After long using, it is allowed partial discoloration of fabrics covering of the cuff. It is not allowed the laundry of the cuff, as well as ironing by hot flatiron.

**WARNING:** Under no circumstances may you wash the inner bladder!

6. Since neither the device nor batteries are household waste, follow your local recycling rules and dispose them at appropriate collection sites.
7. Do not open the device. It is delicate electrical components and an intricate air unit that could be damaged. If you can not fix the problem using the troubleshooting instruction, request service from your dealer.
8. It is generally recommended to have the monitor inspected every 2 years, to ensure proper functioning and accuracy and safety. Please contact your dealer for maintenance.

**WARNING:** Do not modify the equipment without authorization of the manufacturer.

## TROUBLESHOOTING

SYMPTOM	CHECK POINT	REMEDY
No display when the START button is pressed.	The battery have run down	Charge the battery with the adapter or replace the battery with new one.
	The polarity of battery is wrong	Install the battery correctly. Clean the battery terminals with dry cloth.
	The contact of battery compartment is polluted	
The reading is extremely low or high	Is the cuff at the same level as the heart ?	Make sure that your posture is right
	Is the cuff wrapped right?	Wrap the cuff correctly
	Did you strain your arm during measurement?	Relax during measurement
	Did you talk or move your arm (or hand) during measurement?	Keep quiet and silent during the measurement
The battery are run down soon	Faulty battery are used	Use only rechargeable battery recommended in the manual
The device is automatically turned off	It is the result of automatically turn off system	This is to save the power consumption of the device, and it is not a fault.

## WARRANTY OBLIGATIONS

1. Warranty for this digital blood pressure monitor is 24 months since the date of purchase. The 24 months warranty excludes the monitor cuff. The cuff is warranted for 12 months.
2. The warranty obligations are prescribed by warranty certificate for buyer.
3. The addresses of organizations for guarantee maintenance are present in the warranty certificate.

## SPECIFICATIONS

Model	LD-528
Size	174 (L)x70.5 (W) ×40 (H)mm
Weight	Approximately 210g without battery
Measuring method	Oscillometry
Measuring range	40 to 260 mmHg (blood pressure) 40 to 160 beats/minute (pulse rate)
Measuring accuracy	± 3 mmHg for static pressure ± 5% of the reading for the pulse rate
Inflation	Automatic by the pump
Rapid deflation	Automatic by electronic valve
Memory	90 sets of memories
Operation temperature and humidity	+10°C to + 40°C, 85% and below
Storage temperature and humidity	-20°C to + 50°C, 85% and below
Cuff size	Applicable for arm size 22 -32 cm
Complete kit	Main body, storage bag, cuff, rechargeable battery, adapter, instruction manual, warranty card

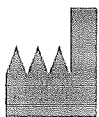



Guidance and manufacturer's declaration-electromagnetic immunity

Guidance and manufacture's declaration- electromagnetic immunity

The model LD-528 Digital sphygmomanometer is intended for use in the electronic environment specified below. The customer or the user of the model LD-528 Digital sphygmomanometer should assure that it is used in such an environment.

Emission test	Compliance level	Electromagnetic environment-guidance
RF emissions CISPR 11	Group 1	The model LD-528 Digital sphygmomanometer uses RF energy only for its internal function. Therefore, its RF emissions are very low and aren't likely to cause any interference in nearby electronic equipment.
RE emission CISPR 11	Class B	The model LD-528 Digital sphygmomanometer is suitable for use in all establishments, including domestic establishments and those directly connected to the public low-voltage power supply network that supplied building used for domestic purposes.
Harmonic emission IEC 61000-3-2	Class A	
Voltage fluctuations/ flicker emissions IEC 61000-3-3	Complies	

Guidance and manufacture's declaration- electromagnetic immunity

The LD-528 Digital sphygmomanometer is intended for use in the electromagnetic environment specified below. The customer or the user of the LD-528 Digital sphygmomanometer should assure that it is used in such an environment.

Immunity test	IEC 60601 test level	Compliance level	Electromagnetic environment-guidance
Electrostatic discharge (ESD) IEC 61000-4-2	±6 kV contact ±8 kV air	±6 kV contact ±8 kV air	Floors should be wood, concrete or ceramic tile. If floors are covered with synthetic material, the relative humidity should be at least 30%.

Guidance and manufacturer's declaration- electromagnetic immunity

Guidance and manufacture's declaration- electromagnetic immunity

Immunity test	IEC 60601 test level	Compliance level	Electromagnetic environment-guidance
Electrical fast transient/burst IEC 61000-4-4	±2kV for power supply lines ±1kV for input/output supply lines	±2kV for power supply lines ±1kV for input/output supply lines	Main power quality should be that of a typical commercial or hospital environment
Surge IEC 61000-4-5	±1kV differential mode ±2kV common mode	±1kV differential mode ±2kV common mode	Main power quality should be that of a typical commercial or hospital environment
Voltage dips, short interruptions and voltage variations on power supply input lines IEC 61000-4-11	<5% $U_T$ (>95% dip in $U_T$ ) for 0.5 cycle 40% (60% dip in $U_T$ ) for 5 cycles 70% $U_T$ (30% dip in $U_T$ ) for 25 cycles <5% $U_T$ (>95% dip in $U_T$ ) for 5 sec	<5% $U_T$ (>95% dip in $U_T$ ) for 0.5 cycle 40% (60% dip in $U_T$ ) for 5 cycles 70% $U_T$ (30% dip in $U_T$ ) for 25 cycles <5% $U_T$ (>95% dip in $U_T$ ) for 5 sec	Main power quality should be that of a typical commercial or hospital environment. If the user of the LD-528 Digital Sphygmomanometer Equipment requires continued operation during power mains interruptions, it is recommended that the LD-528 Digital Sphygmomanometer Equipment be powered from an uninterruptible power supply or a battery.
Power frequency (50Hz) magnetic field IEC 61000-4-8	3A/m	3A/m	Power frequency magnetic fields should be at levels characteristic of a typical location in a typical commercial or hospital environment.

NOTE:  $U_T$  is the a.c.mains voltage prior to application of the test level.

Guidance and manufacture's declaration- electromagnetic immunity

The LD-528 Digital Sphygmomanometer is intended for use in the electromagnetic environment specified below. The customer of the user of the LD-528 Digital Sphygmomanometer should assure that it is used in such an environment.

Immunity test	IEC 60601 test level	Compliance level	Electromagnetic environment-guidance
Conducted RF IEC 61000-4-6	3Vrms 150kHz to 80 MHz	3Vrms	<p>Portable and mobile RF communications equipment should be used no closer to any part of the LD-528 Digital Sphygmomanometer, including cables, than the recommended separation distance calculated from the equation applicable to the frequency of the transmitter. Recommended separation distance</p> $d = \left[ \frac{3.5}{V_1} \right] P$
Radiated RF IEC 61000-4-3	3V/m 80MHz to 2.5 GHz	3V/m	$d = \left[ \frac{3.5}{V_1} \right] P$ <p>80MHz to 800MHz</p> $d = \left[ \frac{7}{V_1} \right] P$ <p>800MHz TO 2.5GHz</p> <p>Where P is the maximum output power rating of the transmitter in watts(W) according to the transmitter manufacturer and d is the recommended separation distance in metres(m).<sup>b</sup> Field strengths from fixed RF transmitters, as determined by an electromagnetic site survey,<sup>c</sup></p>