

AMPLIDECT™ 260



Contents

English

CONTENTS

Introduction	3
Unpacking	4
Description	5
General Description	5
LCD Window Icons Description	9
Installation	11
Connecting Lines	11
Installing Batteries	12
Charging Handset	14
Installing battery in the base	15
Using Handset Carrying Clip	16
Basic Functions	17
Turning Handset On/Off	17
Menu Navigaion	18
Making a call	19
Receiving a call	20
Muting the Microphone	20
Amplification function	21
Ringer Setting	23
Talking Caller ID	24
Level volume for the speaker or the receiver function	25
Last Number Redial	26
Key Lock	28

CONTENTS

Auto Answer	29
Selecting a Language	30
HS Name	31
Range Alarm and Other Alarms	32
Paging	33
Dial Mode	34
Handsfree	35
Flash Signal	36
Advanced Functions	37
CID Book	37
Phone Book	41
One-Touch Memories	47
BS Settings	48
HS Settings	50
Registration	56
Calling with more than one Handset	57
Caller ID on call waiting	60
Feature List	61
Troubleshooting	62
Technical Specifications	64
DSL Filters	63
Safety Information	66
Guarantee	68
Recycling Directives	70

INTRODUCTION

Congratulations on purchasing your Geemarc AD260 telephone. This telephone offers all the advantages of cordless technology (compliant with Digitally Enhanced Cordless Telecommunications-DECT standard) together with an easy to see big button keypad, ideal for those who suffer with poor sight. This telephone is also hearing aid compatible.

Its is important that you read the instructions below in order to use your Geemarc telephone to its full potential. Keep this user guide in a safe place for future reference.

This guide explains how to use the following telephone:

AD260



AMPLIDECT™ 260

INTRODUCTION

Unpacking

When unpacking the telephone, you should find the following in the box:

- 1 AD260 handset
- 1 AD260 base
- 1 Mains power adaptor
- 2 AAA Ni-MH Batteries
- 1 Telephone line cord
- 1 Carrying clip
- 1 User Guide

* The shape of the plugs can vary according to each country's specification.



For product support and help visit our website at

www.geemarc.com

Telephone 01707 384438

Or fax 01707 832529

DESCRIPTION





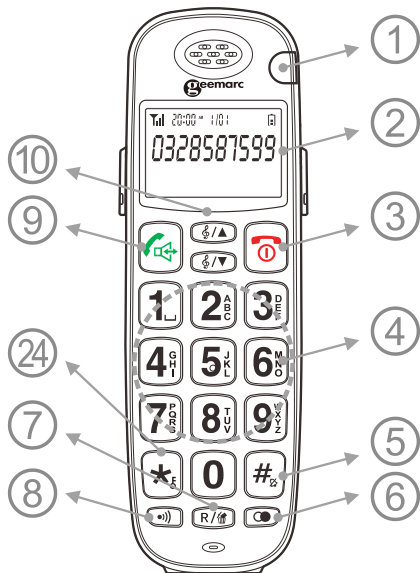

General Description

Front of Handset



1. In-Use/Ring Flash/Voice Mail/Missed Call Indicator
2. LCD Display
3.  key: Press to end a call or return to off-line
4. Keypad

DESCRIPTION

5.  key: Hold it for 5 seconds, enables “Do not disturb”
6.  Key: Redial/Pause
7.  Key: Flash/Delete Key. Generate a “Flash” signal to activate Call Waiting. Delete a digit when inputting text. Go back one level in the Menu system
8. PAGE key: Press to intercom or transfer a call
9.  key: Press to make or answer a call. During a call, press to activate speakerphone
10.  and  keys: Press to control tone or scroll through menu options.
24.  key: Press and hold to turn on/off keypad lock function. Set up a conference call.

DESCRIPTION

Rear of Handset

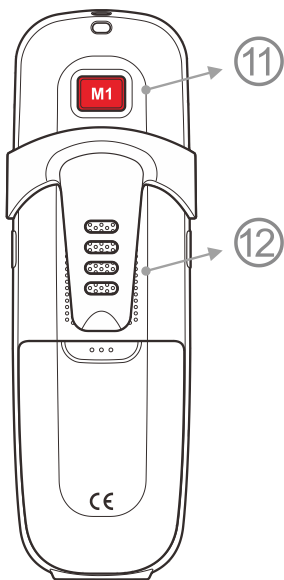



11. **M1** key: One touch memory that also activates speakerphone
12. Speaker

DESCRIPTION

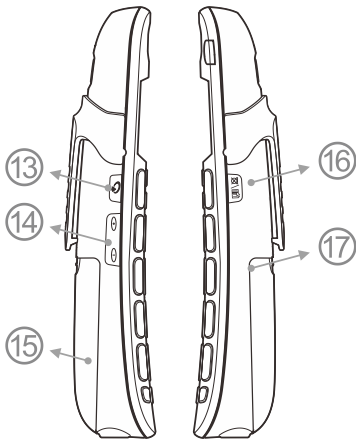
Side of Handset



- 13.  key: Press to receive extra receiver amplification
- 14. Volume Up and Down
- 15. Battery Compartment Cover
- 16. Menu Key(/ ): Press to access menu or sub-menu option. Press to mute/unmute the microphone during a call.
- 17. Belt Clip

DESCRIPTION

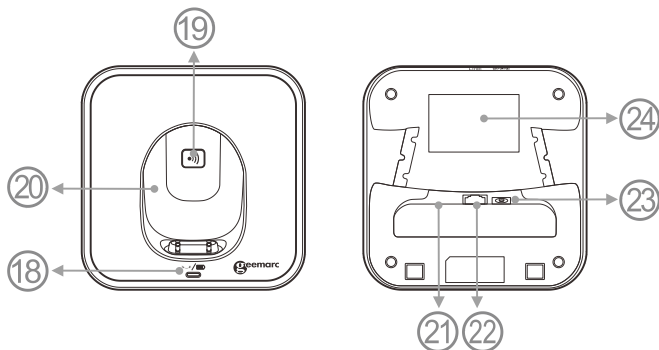

Front of Base

18. In-Use Indicator/Charge Indicator

19. Page key: Press to page all registered handsets

20. Cradle

Underside of Base

21. Base Ringer

22. Telephone Jack: For connection to phone line

23. AC Adaptor Jack: For connection to mains electric power

24. Battery Compartment Cover

DESCRIPTION

LCD Window Icons Description

The LCD screen is split into two distinct areas:

The icon area. This is found at the top of the screen.



This displays the various system icons which help you to use the telephone.

The main area. This is found across the centre of the screen. It displays the following:

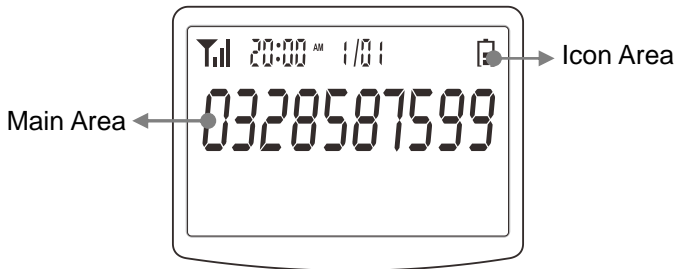
- number being dialled
- call display information
- phonebook
- menu information
- in standby mode, handset number



DESCRIPTION

NEW	New Call Indicates you have missed one or more calls
Voice Mail	MSG Waiting Indicates you have one or more voice messages.
TALK	Off Hook Indicates the line is engaged.
SPEAKER	Hands-free Indicates the handsfree function is enabled.
	Battery Icon This is always displayed when your telephone is switched on. It shows the level of battery charge. More bars indicate more battery charge.
	Signal Icon Indicates the current signal strength. More bars indicates more signal strength. If the handset is too far from the base, this icon will blink on the LCD.
	Alarm Icon This icon appears when you set an alarm to ring at a specified time.

INSTALLATION

Connecting Lines

1. Connect one end of the phone line cord to the phone line jack of the base, and the other end to a standard phone wall outlet.
2. Connect the modular end of the AC power adapter to the power jack of the base, then plug the AC adapter into a standard AC wall outlet.

Ensure you situate the telephone close enough to the power socket so that the cable will reach safely without stretching. Also, the mains power needs to be easily accessible in case you need to disconnect the power.

Make sure the telephone is at least 1 metre away from other electrical products e.g. TV, radio and monitors so as to avoid interference. Also, avoid direct heat and sunlight.

We advise you to place the telephone on a table cloth or similar, as the rubber feet on the base can mark some surfaces

INSTALLATION

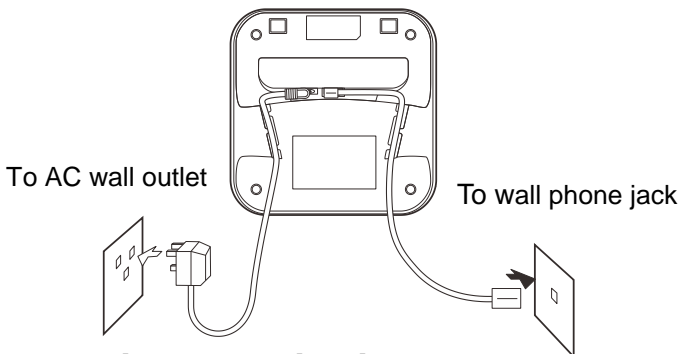

Installing Batteries in the handset

The rechargeable Ni-MH batteries (AAA size) are supplied with your phone. Install the two batteries before using your phone.

1. Slide the battery cover in the direction of the arrow and pull it out.
2. Insert new batteries as indicated, matching correct polarity (+,-).

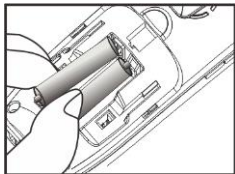

INSTALLATION

3. To replace the battery cover, slide the cover up until it snaps in place.



Notes:

The batteries need to be replaced if they do not recover their full storage capacities after recharging.

When replacing the batteries, always use good quality Ni-MH re-chargeable batteries. Never use other batteries or conventional alkaline batteries.

Fully charged handset batteries can provide 80 hours of standby or 8 hours of talk time.

INSTALLATION

Charging Handset

Important Note: Before initial operation, **YOU SHOULD FULLY CHARGE THE HANDSET** for about **15** hours.

To charge the handset, you should place it on the base.

Result: When you place the handset on the base, the handset automatically turns on.

Installing Battery in the base

The base use special NiMH rechargeable batteries in case of mains power failure. This battery is not provided. Never use non re-chargeable battery.

Fully charged base batteries can provide 4 hours of AC power outage backup.

To place a order of this battery, please contact the after sales service to +44 (0) 1707 384 438.

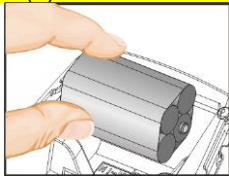

INSTALLATION

Using Handset Carrying Clip

The supplied handset carrying clip allows you to conveniently carry the handset with you. It clips easily to your belt, waist band, or shirt pocket.

If you want to remove the carrying clip:

Insert a screw driver along the edge of one of its arms and release the clip. Then lift it off.

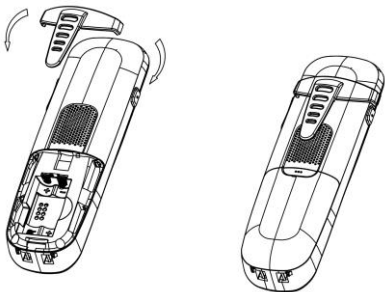

BASIC FUNCTIONS

Turning Handset On/Off

If the handset is in power off mode, when you place the handset on the base, it automatically turns on. To turn the handset on or off in standby mode, follow these steps:

1. To turn on the handset when off, press and hold the



key until you switch the display on. On power up, the handset will enter subscription mode and search for a registered base..

Note: If the handset is successful in finding a base, the handset will enter the standby mode, the display will show handset number and the handset name (if you have one saved), signal icon, battery icon and current time. If the handset is unsuccessful in finding a base, the handset will behave according to the **Out of Range** condition.

2. To turn the handset off, keep the  key pressed until the display turns off.

Note:







Nothing will appear on the LCD when battery power is very low. **YOU SHOULD FULLY CHARGE THE HANDSET BEFORE USING.**

BASIC FUNCTIONS

All descriptions in this manual assume that the handset is in standby mode. Set the telephone to standby mode by pressing the  key.

Menu Navigation

To access a menu option:

1. To display menu items, press the **Menu**(/) key.
2. To scroll through menu options, press the  and  key repeatedly.
3. To select a menu or menu option, press the / key when the desired menu appears on the LCD.

To return to Standby mode from any menu:

To return to Standby mode from any menu, press the  key.

Also, the phone will automatically return to Standby mode from any menu if no key is pressed for about 40 seconds.

To go back one level

To go back one level within the menu system, press  key.

BASIC FUNCTIONS

Making a Call

1. Pick up the handset and press the  key. The **TALK** icon appears on the LCD.

2. Dial a telephone number.

3. To end the call, either press the  key or replace the handset on the base.

You can also enter the desired phone number in standby mode. This allows you to make corrections before dialing. Follow these steps:

1. Enter a telephone number (up to 32 digits). Check it.

You can use the key  to insert a 2 second pause (sometimes required to access an outside line on some business phone systems).

Note: If you make a mistake while entering a number, press the key  to clear the last digit.

2. When the number appears correctly, press the  key.

BASIC FUNCTIONS

Receiving a Call

When a call is received, the **Call** information will appear and the LED will flash.

If the caller can be identified, the caller's phone number is displayed. If the caller cannot be identified, only the **Call** information displays. If you have a voice message, the message "**VOICE MAIL**" will be shown on the LCD.

1. To answer the call, press the  key. If you have activated the Auto Answer function, when the handset is on the base, simply lift it up to answer.

2. To end the call, either press the  key or replace the handset on the base.

After you hang up the call, the LCD displays the call duration.

Notes: You can select the ringer volume by using the Vol +/- key when the phone rings with an incoming call.

Muting the Microphone

During a conversation, you can temporarily switch your phone's microphone off, so that the other party cannot hear you.

BASIC FUNCTIONS

Example: You want to say something to another person in the room but do not want the other party to hear you. To mute your microphone, press the **Mute** () key during the conversation. The "**Call Muted**" appears on the LCD.



To unmute the microphone, press the  key again. You will restore the normal condition.

Amplification Function

Volume Control (Handset and Speakerphone)

While on a call press the volume key on the left side of the handset to change the volume setting. The volume setting is indicated on the screen VL1 to VL5. The receiver volume adjustment is 0-18dB.



Amplification Boost

Your phone is equipped with a specialized amplification function designed to fit your hearing needs. During a conversation you can turn on the  key on the left side of the handset. This will boost the volume during a call. To turn off the amplification boost, simply press the  key again. When this function on, the handset receiver volume adjustment is 32-50dB.

BASIC FUNCTIONS











Tone Control

You can also adjust the Tone control to fit the levels to your hearing requirements. Whilst on a call and when

 has been selected, digital tone control becomes active. Using  and  keys, you can scroll through the four tone options available. The digital tone setting is indicated on the screen as T1 to T4.

Automatic Amplification

The **AMP** function can be set to ON automatically every time the phone is used

1. Press the **Menu**(/) key.
2. Press  until **HS SETTINGS** displayed, then press the / key.
3. Press  until **AUDIO SETUP** displayed, then press the / key.
4. Press  until **AMPLIFY** displayed, then press the / key.

BASIC FUNCTIONS

5. Press  until **ON** displayed, then press the  key to confirm.



Ringer Setting

You can select your own external (from the telephone Network) or internal (from other handsets registered to the same base) ring tone and adjust the volume.

1. Press the **Menu**() key.

2. Press the  and  keys to choose **HS Settings** menu, then press the  key.



3. Press the  and  keys to choose **Ring Setup**, press the  key.





4. Press the  key to choose **INT Ring** or press the  key to choose **EXT Ring**, press the  key.

5. .Press the  key to choose **Melody**

Note: You can select the **Melody** from Melody 1 to 10 using  and .When you adjust the ringer

BASIC FUNCTIONS

setting, the phone plays the selected melody, press the /  key to confirm the desired ringer.

At step 4, press  to select **Volume**, and press the /  key, you can adjust the ringer volume from **Volume 1** to **Volume 5**, or **Volume Off** to turn off the ringer. Press the /  key to confirm.

Notes:

- If you set the volume to "Off", when a call comes in, only the New Call information appears on the LCD.
- You can also use the + or - control to adjust the ringer volume when you receive a call.

Talking Caller ID/ Talking Keypad



The AD260 is capable of speaking the numbers that you press on the numeric keypad (Talk Keypad) and also announcing the telephone number of any incoming call (Talk CID).



1. Press the **Menu**(/ ) key.

2. Press the  and  keys to choose **HS Settings** menu, then press the /  key.

BASIC FUNCTIONS

3. Press the  and  keys to choose **Audio Setup**, press the  key.

4. Press the  and  keys to choose **Talk CID**, press the  key.

5. Use the  or  key to choose **On/Off** to enable/disable Talking Caller CID, then press the  key, you will hear a confirm beep.

For the **Talking Keypad** function at step 4, choose **Talk Keypad** instead of **Talk CID** and continue with step 5.

Level volume for the speaker or receiver

You can set the volume level for the speaker or the handset when you pick up the line.



For the function **RCX Volume**, follow the instruction of the last chapter and at the point 4 choose **RCX Volume** instead of **Talk CID**.

After you have chosen the level of the volume, press the Menu key, you will hear a confirmation beep.

For the Function **SPK Volume**, follow the same instruction as before and replace the **TALK CID** by **SPK Volume** function.



BASIC FUNCTIONS

Last Number Redial

1. Press the  key to take the line.
2. Press the key .



The LCD displays the last number you dialed and the phone dials out the number.

or

1. Press the  key in Standby mode.
2. Press the  key to dial out the number.

Search for and dial a number in Redial Book

Your phone allows you to retrieve the last 10 numbers you have dialed.

1. Press the  key in Standby mode.
2. If you want to scroll through the memory, press the  key repeatedly until you find the number you want to dial.
3. Press the  key to dial out the desired number.

Notes:





- If no numbers are found, "**Empty**" is displayed.

BASIC FUNCTIONS

- When the redial book is full, each time you dial a new number, the oldest number stored in the redial book is automatically erased and replaced with the latest number.



Use Redial Book options

Using the redial book options, you can add a number to phone book or delete a number in the redial book.

1. Press the  key.
2. Scroll to the desired number by using the  and .
3. When the desired number appears on the display, press the **Menu** key to select an option:
 - **Add to PB:** allows you to add the number to the phone book. Complete storing the entry by starting from described in "Adding a Phone Book Entry" (obviously, you will find the number already entered in the appropriate field).
 - **Delete:** allows you to delete the selected number.
 - **Delete All:** allows you to delete the whole redial book.
4. To return to Standby mode, press the  key.

Note:

BASIC FUNCTIONS

- At step 3, when you select **Delete** or **Delete All** options, a message "**Confirm ?**" will further ask you to confirm the deletion. To confirm press the  key, to escape press the  key.

Key Lock

If you turn this feature on, all keys will be locked. You can answer calls by using the  key on the phone. But when you hang up, the phone returns to the locked mode. This feature is useful to avoid pressing keys by mistake.

To lock the keys, in the Standby mode just keep the  key pressed till the display shows "HS Locked".

To unlock the keys, keep the  key pressed again till "**HS Unlocked**" appears on the display and ear a beep.















Note:

- In locked mode, if you press any key, the phone will generate an error tone, and the "**HS Locked**" message will be redisplayed.

BASIC FUNCTIONS

Auto Answer















With this feature, you can answer a call by just picking up the handset from the base without pressing any key.

1. Press the **Menu** (/) key.
2. Press the  and  key repeatedly to choose **HS Settings**, press the / key.
3. Use the  and  key to choose **Auto Answer**, press the / key.
4. Use the  and  key to choose **On/Off** to enable/ disable the function, then press the / key, you will hear a confirm beep.

BASIC FUNCTIONS

Selecting a Language

The Handset supports multiple predefined languages. You can change the language used to display the menu messages.

1. Press the **Menu** (/) key.
2. Press the  and  key to choose **HS Settings**, then press the / key.
3. Use  and  key to choose **Language**, then press the / key.
4. The languages will be displayed. Use the  and  key to scroll through the options. Each language will be displayed in its own native translation.
5. Press / key to select the required language and you will hear a confirm beep.

BASIC FUNCTIONS

HS Name

Using this feature you can define a name of the handset. This allows you to easily recognize your handset if you have more than one registered on the same base. To set the handset name:













1. Press the **Menu** (☒/☒) key.
2. Press the (🎵/▲) and (🎵/▼) key to choose **HS Settings**, press the ☒/☒ key.
3. Use the (🎵/▲) and (🎵/▼) key to choose **HS Name**, then press the ☒/☒ key.
4. You can enter the handset name (up to 12 characters) by using the numeric keypad (see Add Phone book Entries) Use the key (R/☒) to delete any incorrect characters, then press the ☒/☒ key to confirm and exit.

Once you have assigned a handset name, HS1 will be displayed for about 5 seconds and then your given handset name will be displayed for about 5 seconds.

BASIC FUNCTIONS

Range Alarm and Other Tones

A beep will sound when the handset is out of range of the base. You are able to select to enable/disable this audible warning.

1. Press the **Menu** () key.
2. Press the  and  key to choose **HS Settings**, press the  key.
3. Use the  or  key to choose **Tone Setup**, then press the  key.
4. Use the  or  key to choose **Range Alarm**, then press the  key.
5. Use the  or  key to choose **On/Off** to enable/disable this audible warning, then press the  key, you will hear a confirm beep.

There are two other tones that can be switched on or off on the AD260:

- **Key Tone** - Every time you press a key, your handset acknowledges it with a key tone. You can disable the key tones for silent use. In

BASIC FUNCTIONS

certain error conditions, a warning tone will still sound when an incorrect key is pressed.

Note: For normal use, we recommend you leave the key tone enabled. This makes the phone easier to use.

- **Battery Low** - If handset batteries are running low, there will be an audible beep

To switch either of these on or off, select Key Tone or Battery Low instead of Range Alarm in the above set of instructions

Paging

You can page the handset from the base unit. The handset will ring with a special tone. This is useful to locate a lost handset.

Press the  key on the base unit (less than 5 seconds), all the handsets registered to the base will ring for about 60 seconds.

To stop paging, press the  key on the base again or any key on the handset.











Note:

BASIC FUNCTIONS

- On a long  key press, more than or equal to 5 seconds, the base will enter subscription mode. For details.

Dial Mode

You can change the dial mode using the following steps:

1. Press the **Menu** () key.
2. Press the  and  key to choose **BS Settings**, and press the  key.
3. Use the  or  key to choose **Dial Mode**, then press the  key.
4. You can press the  or  key to select the required dial mode options (**Tone/Pulse**) and press the  key. A confirm beep will be heard.

Note:

If you are not sure which dialing mode to select, please contact your local service provider. The default setting is Tone.

BASIC FUNCTIONS

Handsfree

During a call, you may turn on the speakerphone built in the handset. In this mode you can simply put your handset on a surface (e.g. a desk) and enjoy the comfort of the handsfree conversation.

To turn the feature on, press the  key during a call (line engaged). The SPEAKER icon appears on the LCD.

To turn the feature off, and keep on talking in normal mode, press the  key again. The SPEAKER icon will disappear.

Notes:

- Before putting the handset near your ears, be sure you have turned the speakerphone off.
- To adjust the speakerphone volume, use the Vol + and Vol- keys.

BASIC FUNCTIONS

Flash Signal

When the line is engaged, pressing the key  sends the Flash signal (the display will show **F**). This key is used in conjunction with special services (e.g. call waiting) which may be available on your phone network. For further details please contact your network telephone company.

ADVANCED FUNCTIONS







CID Book

When you receive a call, if the caller's information is transmitted from the network on which the call was made (and the caller doesn't hide it), the caller's phone number is displayed. Moreover, when there is a received call which you missed, the NEW icon will appear on the LCD. If the CID memory is full, the NEW icon will blink on the LCD.



Out of area - This message will display when someone calls from an area where the telephone company is not offering the caller identification services or is not yet providing number delivery to your area.

P - If the caller has exercised the option to prevent his name and number from being sent, the message will show on the LCD.

Viewing the CID Log

1. Press the **Menu** (/) key.
2. Press the / key again to choose **Call Log**
3. Press the / key again to choose **Received..**















ADVANCED FUNCTIONS

- CID Log will be displayed. Use  or  to scroll through the list.
- The display shows **Empty** if there are no CID log entries.



Dialing a Number from CID Log



Find the number you want to dial. Refer to "Viewing the CID Log". Then press the  key.





Add CID Log Entry to Phone book

- Press the **Menu** (/) key.
- Press the / key again to choose **Call Log**
- Press the / key again to choose **Received..**
- CID Log will be displayed. Use  or  to scroll through the list to find the number you wish to add to the Phone book. Press / key.
- Press  or  to choose **Add to PB?**, press the / key

ADVANCED FUNCTIONS



6. The display shows "**Name ?**". Enter the name you want to use (see Add Phone book Entries), then press the /  key.

7. The CID number will be displayed, press the /  key.



8. Use  or  key to select the ring you would like to associate with the number, press the /  key to confirm.

Deleting a CID Entry





1. Press the **Menu** (/ ) key.

2. Press the /  key again to choose **Call Log**



3. Press the /  key again to choose **Received..**

4. CID Log will be displayed. Use  or  to scroll through the list to find the number you wish to delete,









5. Press /  key.

6. Press  or  to choose **Delete** , press the /  key.

ADVANCED FUNCTIONS

7. The display will show "**Confirm**". You can press the  key to delete the entry or press the  key to cancel and exit.

Deleting all CID Log Entries

1. Press the **Menu** ()key.
2. Press the  key again to choose **Call Log**
3. Press the  key again to choose **Received..**
4. CID Log will be displayed.
5. Press  key.
6. Press  or  to choose **Delete All**, press the  key.
7. The display will show "**Confirm**". You can press the  key to delete all entries or press the  key to cancel and exit.

ADVANCED FUNCTIONS

Phone Book

The phonebook built in your cordless phone allows you to store frequently used numbers so that you can easily make a call without having to remember or enter the phone number.

Character Map











To enter a specific alphanumeric character, press the relevant key one or more times for the required character according to the following table: once for the first character, twice for the second and so on.

Key	Characters in the displayed order									
0	0	SP	+	-	@	=	/	\	[]
1	Sp	1	;	?	?		!	'	"	()
2	A	B	C	2						
3	D	E	F	3						
4	G	H	I	4						
5	J	K	L	5						
6	M	N	O	6						
7	P	Q	R	S	7					
8	T	U	V	8						
9	W	X	Y	Z	9					



SP = Space

ADVANCED FUNCTIONS

Add Phone book Entries

1. Press the **Menu** () key.
2. Press  to choose **Phonebook**, press the  key.
3. Press  to choose **New entry**, press the  key.
4. The display shows "**Name ?**". Enter the name you want to use, then press the  key to confirm. The display shows "**Number ?**". Enter the desired number (up to 20 digits), press the  key.
5. Use  or  key to select the ring you would like to associate with the number, press the  key to confirm.

Note:







- If you make a mistake while entering a name or a number, use the key  to correct it. Each time you press the key, the last digit is deleted. To clear all digits, press and hold the key .

ADVANCED FUNCTIONS

Using a Pause

A pause is useful when you access an interactive voice response system e.g. an automated banking system. A pause provides a delay of 3 seconds. If you want to insert a pause when you dial a number in standby mode or store a number in the phonebook, press the key . The letter **P** will appear at the pause entry.

Viewing the Phone book Entries













1. Press the **Menu** () key.
2. Press  to choose **Phonebook**, press the  key.
3. **List** will be displayed, press the  key.
4. Phonebook Entries will be displayed. Use  and  to scroll through the list. The entries are listed in alphabetical order.
5. The display shows **Empty** if there are no Phone book entries.

ADVANCED FUNCTIONS



Dialing a Number from Phone book

Find the number you want to dial. Refer to "Viewing the Phone book Entries". Then press the  key.

Editing the Phone book Entries

1. Press the **Menu** () key.
2. Press  to choose **Phonebook**, press the  key.
3. Press  and  to choose **Edit**, press the  key.
4. Use  and  to scroll through the list of numbers in the Phone book until you find the number you wish to edit, press the  Key.
5. Edit the name. If necessary, press the key  to clear the digit(s) then enter the desired, correct name, press the  key to save.
6. Edit the number. If necessary, press the key  to clear the digit(s) then enter the desired, correct number, press the  key to save.

ADVANCED FUNCTIONS



7. Use the  and  key to select the ring you would like to associate with the number, press the  key to confirm.



Deleting a Phone book Entry

1. Press the **Menu** () key.

2. Press  to choose **Phonebook**, press the  key.















3. Press  and  to choose **Del Record**, press the  key.

4. Use  and  to scroll through the list of numbers in the Phone book until you find the number you wish to delete, press the  Key.

5. The display will show "**Confirm**". You can press the  key to delete the entry or press the  key to cancel and exit.













ADVANCED FUNCTIONS

Deleting all Phone book Entries

1. Press the **Menu** (/) key.
2. Press / to choose **Phonebook**, press the / key.
3. Press / and / to choose **Delete All**, press the / key.
4. The display will show "**Confirm**". You can press the / key to delete all the entries or press the  key to cancel and exit.

Mem Status

The Memory Status shows the number of phone book entries already stored.

1. Press the **Menu** (/) key.
2. Press / to choose **Phonebook**, press the / key.
3. Press / and / to choose **Mem Status**, press the / key.

ADVANCED FUNCTIONS

4. The display shows the current phonebook status, for example, **07/150 Used**. It means 150 records can be stored in the phonebook. Out of the 150, 7 have been stored.

One-Touch Memories

You can store 1 number in the direct memory,

Storing Memory Numbers

Type in the desired number and then press and hold M1 button to store. When it has been stored, a confirmation beep will be heard and you will be returned to standby.

Dialing from One-touch Memories

In the standby mode, press **M1** to dial out the number. The number will be dialled and Handsfree mode will be started automatically.









This is a useful emergency key and it is worthwhile storing the number of someone who would help you in case of emergency.

ADVANCED FUNCTIONS

BS Settings

Delete Handset

This function allows you to delete a handset registered to the base.

1. Press the **Menu** () key.
2. Press the  and  key to choose **BS Settings**, then press the  key.
3. Press the  key to choose the **Delete HS** menu. The display shows "PIN?" to prompt you to enter the PIN Code (The default PIN Code is "0000"). Then press the  key.
4. Use Up  and  key to select a handset, press the  key to confirm. After that, the deleted handset cannot be used with the base, it can be re-registered to the base if needed. If you select the current handset, a warning tone will be heard.

Base Default











If you reset the base, all the features will be restored to the factory initial settings.

See the procedure in page 54.

ADVANCED FUNCTIONS





Flash Time

You can select to change the Flash time as follows:







1. Press the **Menu** () key.
2. Press the  and  key to choose **BS Settings**, then press the  key.
3. Use the  and  key to choose **Flash Time** menu. Press the  key.
4. The display shows the current setting. Use the  and  key to select **100ms/ 300ms/ 600ms**, press the  key to confirm.

Modify PIN

This function allows you to change the PIN number of the currently active Base. The default PIN is 0000.

1. Press the **Menu** () key.
2. Press the  and  key to choose **BS Settings**, then press the  key.





ADVANCED FUNCTIONS

3. Use the  and  key to choose **Modify PIN** menu. Press the  key.
4. The display shows "PIN?". Enter the current PIN, then press the  key. If the old PIN code is validated, you will be prompted to enter a new PIN code. If the old PIN is not validated, a warning beep will sound and you will be returned to the **Modify PIN** menu.
5. Enter the new PIN, press the  key. You will be requested to confirm the PIN code. Enter the new PIN again then press the  key to confirm and exit.





HS Settings

Setting Alarm

You are able to set the alarm on the handset and adjust the alarm settings.

1. Press the **Menu** () soft key.
2. Press the  and  key to choose **HS Settings**, then press the  key.
3. Press the  key to choose **Alarm** menu.

ADVANCED FUNCTIONS

- The display shows the current setting. Use the  and  key to select **On/Off**, press the  key.
- If you select **On**, the display prompts you to enter the time in **HH:MM** format. Use the numeric keypad to enter, press the  key.
- When the alarm sounds, press any key to stop the alarm sound.

Notes:











- At step 5 you need to enter the time in 24-Hour format.
- To stop the alarm please press any key.
- If you choose **Snooze On**, the alarm will ring at regular intervals of 5 minutes. If you press  key on the handset when the alarm sounds, the alarm won't sound again until the next day. However, if you press any other key, the alarm sound will stop but keep on alerting you every 5 minutes.

Setting Date & Time











Date & Time Format

- Press the **Menu** () soft key.

ADVANCED FUNCTIONS

2. Press the  and  key to choose **HS Settings**, then press the  key
3. Press the  and  key to choose **Date & Time** menu, press the  key.
4. Press the  key to select **Time Format**
5. You can use the  and  key to choose the Time format (**12 - Hour/24 - Hour**), press the  key to save.

Setting date & time

1. Press the **Menu** () soft key.
2. Press the  and  key to choose **HS Settings**, then press the  key
3. Press the  and  key to choose **Date & Time** menu, press the  key.
4. Press the  and  key to choose **Set Date** or **Set Time** menu, press the  key to select the required option.

ADVANCED FUNCTIONS











5. Enter the current date/time using the numeric keypad and press the  key to save and exit.

Notes:

- If you select **12-Hour**, **AM/PM** will appear on the right of the time in standby mode.

Selecting a Base









This function allows you to select a base from those already registered to the handset.

1. Press the **Menu** () soft key.
2. Press the  and  key to choose **HS Settings**, then press the  key
3. Press the  and  key to choose **Select Base** menu, press the  key.
4. You can use the  and  key to select the base you want to use, then press the  key.
5. “**BS Selected**” appears after “**Searching**”.

ADVANCED FUNCTIONS

Default

If you reset the handset, all the features will be restored to the factory initial settings.

1. Press the **Menu** () soft key.
2. Press the  and  key to choose **HS Settings**, then press the  key
3. Press the  and  key to choose **HS Default** menu, press the  key.
4. Enter the PIN code (the default one is 0000), then press the  key.

Result: After the resetting, all the handset settings will be restored to the factory default.















There is also a default option in Base Settings. After the resetting, all the base settings will be restored to the factory default.

ADVANCED FUNCTIONS

Call Barring

Call barring allows the user to prevent certain phone numbers with specific prefixes from being dialled out e.g. 0845.

Alternatively, all outgoing calls can be barred.



1. Press the **Menu** () soft key.
2. Press the  and  key to choose **HS Settings**, then press the  key.
3. Press the  and  key to choose **Barring** menu, press the  key. The display shows "**PIN?**" to prompt you to enter the PIN Code (The default PIN Code is "0000"). Then press the  key.
4. You can use the  and  key to choose **External** to stop all outgoing calls, then press the  key.
5. Or press **Select Num** press the  key.
6. Press the  key to select **Number 1**, press the  key. There are 4 records available to store 4 different prefixes to be barred.

ADVANCED FUNCTIONS

7. Enter the prefix to be barred e.g. 0845 or 07 or 09.
8. Press the  key to save and exit.

Do Not Disturb

This function turns off the handset ringer and allows the user to ignore all incoming calls (except intercom calls).

1. Press and hold  key for 5 seconds to enter the Do Not Disturb mode. The screen will display Non Disturb.
2. To turn off the Do Not Disturb function, Press and hold  key again for 5 seconds.



Registration

The supplied handset is already registered with the supplied base (factory setting). Each additional handset you purchase must be registered with the base. You can register up to 5 handsets to your base unit. This means you can make internal calls between registered handsets, transfer an incoming call between handsets and answer a call anywhere in the office or home at any time as all the handsets will call at the same time.

ADVANCED FUNCTIONS

1. Before registering a handset to the base, you should press and hold base unit **•)))** key for about 5 seconds. Release it once the In-Use Indicator/Charge Indicator light on the base starts flashing. The base is now ready for handset registration. The following steps must be completed within 120 seconds.

2. Press the **Menu** () soft key.

Press the  and  key to choose **REGISTRATION**, then press the  key.

Choose **base 1** then press the  key

On the display, you have the information **SEARCHING 1**.

3. Enter the **pin code 0000**. Registration will take about 10 seconds to complete another audible beep will notify you of success with registration.

Calling with more than one Handset

If you have more than one handset registered to the same base, you can make internal calls and transfer an external call between the registered handsets.

Making an internal call

1. Press the **PAGE** key, then enter the handset number you want to call.



ADVANCED FUNCTIONS

2. If the handset entered is valid, the called handset will ring. The called party can press the  key to answer the internal call.

3. At the end of your conversation, press the  key.

Note:

During the internal call, if an external comes in, the LCD will show the caller's number. You should press the

 key to end the internal call first then press the  key to answer the call.

Call transfer between handsets

You can transfer an external call between the handsets that are registered to the same base.

1. During an external call, press the **PAGE** key and then the number of the handset you want to transfer the call to.

2. If the called party can answer your call, he/she can press the  key to talk with you. At this time you can inform him/her of the incoming call.

ADVANCED FUNCTIONS

3. Press the  key or replace the handset to the base to complete the transfer.

Setting up a 3-way conference call

When you have both an external call and an intercom call in progress, you can set up a three-way conference call, like this:

1. During an external call, press the **PAGE** key and then the number of the handset you want to join the 3-way call.

2. The called party must press  key to answer.

3. The calling party can press the  key to start the 3-way call.

4. Either of the two internal handsets can press the  key to leave the conference call at any time.

Note: If one of the handsets drops the conference call, the remaining handsets will continue the conference.

FEATURE LIST

Caller ID on call waiting

When you subscribe to Call Waiting service from your local telephone company, the telephone will display the name and number of the second caller while you are having a conversation.

1. DECT Technology ensures crystal clear conversation
2. Up to 50dB of received amplification (5 volume levels)
3. "AMPLIFY" key that sets receiver volume to amplify as a default.
4. 4 digital tone control settings
5. High performance speakerphone
6. Talking CID and talking keypad (English or French)
7. Large LCD with backlight
8. Wide choice of display languages
9. Loud ringer in handset and base
10. Bright ring flasher in handset and base
11. Handset flasher indicates new voicemail and new call
12. Compatible with FSK CID (Type 11) and voice mail signals
13. Extra large keypad buttons
14. Emergency one touch memory (dials number and turns on speakerphone)
15. 40 Incoming call list memory, 10 outgoing call list memory
16. 150 Phone book memory
17. Max of 5 handsets can be registered to base
18. Non-disturb function

FEATURE LIST

19. Low battery voice warning, out of range alarm
- 20 Auto-answer when lifting handset off base
21. 10 handset ring tones and 5 base ring tones
22. Intercom function
23. Three way conference
24. On-line and off-line buttons
25. Battery back-up option on base
26. Swap battery between handset and base available

TROUBLESHOOTING

Symptom	Check & Remedy
No operation	<ul style="list-style-type: none">• Check that the power adapter is properly connected.• Check that the telephone line cord is properly connected.• Check that the handset batteries have full power.• Check that the handset batteries are installed properly.
No dial tone	<ul style="list-style-type: none">• Check that the telephone line cord is properly connected.• Check that the power adapter is properly connected.• Ensure you are close enough to base• If new handset, ensure it is registered with the base
Nothing appears on the display	<ul style="list-style-type: none">• Check that the handset batteries are installed properly.• Check that the handset batteries have full power.• Check that the handset is on.
Handset seems to have very short battery life	<ul style="list-style-type: none">• Check the charge contacts.• Consistently short battery life may indicate that replacement of the batteries is necessary.• Make sure the correct batteries are used.
Caller's number is not displayed	<ul style="list-style-type: none">• Make sure you have subscribed to a Caller ID service via your network provider.• The caller may have withheld their details.• Let the phone ring a couple of times as

TROUBLESHOOTING

	there may be a delay in receiving the Caller ID information.
If I press  there is no dial tone	Handset probably needs re-syncing with base. Switch off the handset, leave for 10 seconds then switch it back on. They should sync up in about 5-30 seconds
Handset Flasher works but the handset is not working	Ensure handset ringer volume is not set to minimum Ensure Non-Disturb function is not active
Red flasher always blinking	Voice mail waiting in your provider's voice mail server Missed a call, reviewing incoming call list clears this indicator
Static noise on the line	Ensure phone is not located too close to touch lamp, microwave etc. Ensure you have applied DLS filters if using DSL modem service
Talking Voice	English, French, (English voice in Spanish mode)

TECHNICAL SPECIFICATION

Charging time	15 hours
Ambient temperature	Normal: 10°C ~ 30°C, Extreme: -10°C ~ 40°C
Humidity	0%~90%
Weight (oz)	Base: 16; Handset: 5.7
Dimensions (inches)	Base: 6.7 x 3.1 x 5.0; Handset: 7.0 x 2.1 x 1.2
Power Supply	AC Adapter: UL listed 7.5vdc, 500MA Base Battery: 4 xAAA NIMH (Optional, not supplied) Handset Battery: 2 x AAA NIMH (included)
Amplified dB level (AMP off)	0-18 dB in 5 steps
Amplified sB level (AMP on)	32-50 dB
Tone	T1-T4
Display Language	English, French, Spanish, Deutsch, Italiano, Dutch, Pyccknn, Portugues, Polski, Svenska, Dansk, Norsk, Emhnika, Turkce, Ykpaihclkn, Magyar
Talking Voice	English, French, (English voice in Spanish mode)

Design and specifications are subject to change without notice.



If you subscribe to a DSL service

Please attach a noise filter (contact your DSL provider) to the telephone line between the base unit and the telephone line jack in the event of the following:

- Noise is heard during conversations.
- Caller ID features do not function properly.

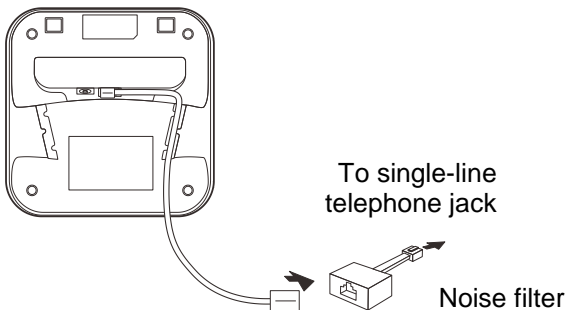

SAFETY INFORMATION

General

Only use the power supply included with the product.

Only use the approved rechargeable batteries supplied.

Do not open the handset (except to replace the handset batteries) or base. Contact the helpline for all repairs. Never dispose of batteries in a fire. There is a serious risk of explosion and/ or the release of toxic chemicals.

Do not place objects on the line cord or power cable that may cause damage.

If you are sure you are not going to use the telephone for over a month, remove the batteries.

Cleaning

Unplug the telephone. Clean the telephone with a soft cloth. Keep the base and handset charging contacts clean. Never use polishes or cleaning agents - they could damage the finish or the electrics inside.

Environmental

Do not expose to direct sunlight.

Always ensure there is a free flow of air over the surfaces of the telephone.

SAFETY INFORMATION

Do not place any part of your product in water and do not use it in damp or humid conditions e.g. bathrooms.

Do not expose your product to fire or other hazardous conditions.

Unplug your phone from the telephone socket during thunderstorms because it could damage your telephone. Your guarantee does not cover thunderstorm damage.

Do not use the telephone to report a gas leak in the vicinity of the leak.

The telephone is designed for working within a temperature range of 5°C to 45°C.

GUARANTEE

From the moment your Geemarc product is purchased, Geemarc guarantee it for the period of two years. During this time, all repairs or replacements (at our discretion) are free of charge. Should you experience a problem then contact our help line or visit our website at www.geemarc.com. The guarantee does not cover accidents, negligence or breakages to any parts. The product must not be tampered with or taken apart by anyone who is not an authorized Geemarc representative. The Geemarc guarantee in no way limits your legal rights.

IMPORTANT: YOUR RECEIPT IS PART OF YOUR GUARANTEE AND MUST BE RETAINED AND PRODUCED IN THE EVENT OF A WARRANTY CLAIM.

Please note: The guarantee applies to the United Kingdom only

DECLARATION: Geemarc Telecom SA hereby declares that this product is in compliance with the essential requirements and other relevant provisions of the Radio and Telecommunications Terminal Equipment Directive 2014/53/UE and in particular article 3 section 1a, 1b and section 2. The telephone does not operate if the line current is lower than 18 mA.

The declaration of conformity may be consulted at www.geemarc.com



GUARANTEE

Electrical connection: The apparatus is designed to operate from a 230V 50Hz supply only. (Classified as 'hazardous voltage' according to EN60950 standard). The apparatus does not incorporate an integral power on/off switch. To disconnect the power, either switch off supply at the mains power socket or unplug the AC adaptor. When installing the apparatus, ensure that the mains power socket is readily accessible.

Telephone connection: Voltages present on the telecommunication network are classified TNV-3 (Telecommunication Network Voltage) according to the EN60950 standard.

RECYCLING DIRECTIVES

The WEEE (Waste Electrical and Electronic Equipment) has been put in place for the products at the end of their useful life are recycled in the best way.

When this product is finished with, please do not put it in your domestic waste bin.

Please use one of the following disposal options:

- Remove the batteries and deposit them in an appropriate WEEE skip. Deposit the product in an appropriate WEEE skip.

- Or, hand the old product to the retailer. If you purchase a new one, they should accept it.

Thus if you respect these instructions you ensure human health and environmental protection.



For product support and help visit our website at

www.geemarc.com

Telephone 01707 384438

Or fax 01707 832529



UGAD260_En_v1.0

geemarc UNITED KINGDOM

5 Swallow Court
Swallowfields
Welwyn Garden City
Hertfordshire, AL7 1SB
For product support.
01707 384438

www.geemarc.com

geemarc FRANCE

Parc de l'Etoile
2, rue Galilée 59791
GRANDE SYNTHÉ CEDEX
TEL. SERVICE APRES VENTE.
03 28 58 75 99

www.geemarc.com